



## HK4020-2RS

Drawn cup needle roller bearing open end

Schaeffler ID:  
0002488350968

Drawn cup needle roller bearings with open ends HK..-2RS, lip seals on both sides, to DIN 618

### Technical information

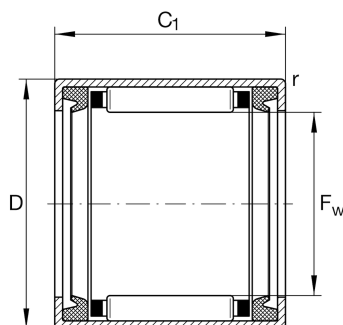

#### Main Dimensions & Performance Data

$F_w$	40 mm	Under roller diameter
$D$	47 mm	Outside diameter
$C$	20 mm	Width
$C_r$	20,000 N	Basic dynamic load rating, radial
$C_{0r}$	38,500 N	Basic static load rating, radial
$C_{ur}$	5,100 N	Fatigue load limit, radial
$n_G$	3,950 1/min	Limiting speed
$n_{G \text{ Grease}}$	3,950 1/min	Limiting speed for grease lubrication
	47.66 g	Weight

#### Dimensions

$C_1$	20 mm	Width, outer ring
$r_{\min}$	0.8 mm	Minimum chamfer dimension
	LR35X40X20,5	Suitable inner rings LR
	IR35X40X20-XL	Suitable inner rings IR

#### Temperature range

$T_{\min}$	-20 °C	Operating temperature min.
$T_{\max}$	100 °C	Operating temperature max.